

Rollon Compact Rail

Rollon Compact rail is a unique linear motion system ideal for general mechanisms and machine building. Compact rail is an internal raceway, roller bearing design that possesses adjustable preload and self-alignment. Where machine tool grade, high load and high precision, are not as critical as a durable, quiet, reliable, easy to install solution, then compact rail is the obvious choice.

Key benefits of Rollon Compact Rail

- Easy and inexpensive to mount to fabricated frames without machining. It even comes complete with fasteners for counter bored rail type.
- Compact dimensions reduce overall machine size and power requirements.
- Self-aligning capabilities reduce manufacturing complexity, and extend service life.
- Protected internal raceways with spring loaded wipers to increase life and durability.
- Unique lubricators that coat the rail with every stroke for up to 10,000 cycles (except 18 series) for longer life.
- Roller bearings give high-speed capabilities with quieter running and ultra-long life.

Field adjustable preload

By mounting one, (or more) sliders on an adjustable cam the Compact Rail sliders have the unique ability to have their preload adjusted in the field. This allows a free running or highly rigid system to be set up to suit the individual machine requirements.

For example, machine design “A” can be set up with a low friction, low rigidity preload to suit a high output, low mass payload. Conversely machine “B” could have a high friction, high rigidity preload for a lower output, higher mass payload requirement, all with the same rail and slider configurations.

Multiple roller options

Sliders are available in a wide variety of roller configurations as well as the standard 3 roller shielded set up. This allows for axial and radial mountings as well as optimised configurations for yawing and overhanging loads.

Counter bored rail and fasteners

Countersunk rails are available for high precision applications but the vast majority of applications suit the standard counter bored rail. Counter bored rails can accommodate errors in fastening holes positions by allowing the rail to move within the oversized counter bore. This makes installation easier and less stressful.

Counter bore rails come complete with low profile Torx head screws to make installation easy. Torx head fasteners offer high torque transmission with lower stress concentrations and less risk of thread “stripping”. These are optimised for the compact rail system to reduce the head size of the fasteners and the overall size of the rail system and are supplied with the rail.

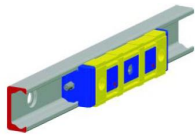
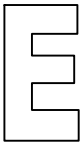

ROLLON

Joining of Rails

Long travel lengths can be achieved using a simple joining tool that aligns the joints between each rail. This means that theoretically unlimited lengths can be achieved and installation can be done in the field. This eliminates the misalignment between rail sections and semi-skilled personnel can perform the installation. Where constant preload is required between rails then factory matched rails are recommended.

Self-aligning capability

Rollon compact rail has an amazing self-aligning capability. Careful selection of rail profiles will allow sliders to take up parallelism errors and avoid the need for precision machined bearing sub frame. The three different profiles have the following characteristics

- T profile** A rigid section that can carry axial & radial loads and can be mounted as a single rail solution.
- U profile** Carries full radial load but has no axial rigidity and is commonly mounted in parallel with a T or K section profile.
- K profile** Carries slightly less axial load to the T profile and no moment about the axis of travel. This allows the slider to rotate in the rail and take up axial parallelism errors.

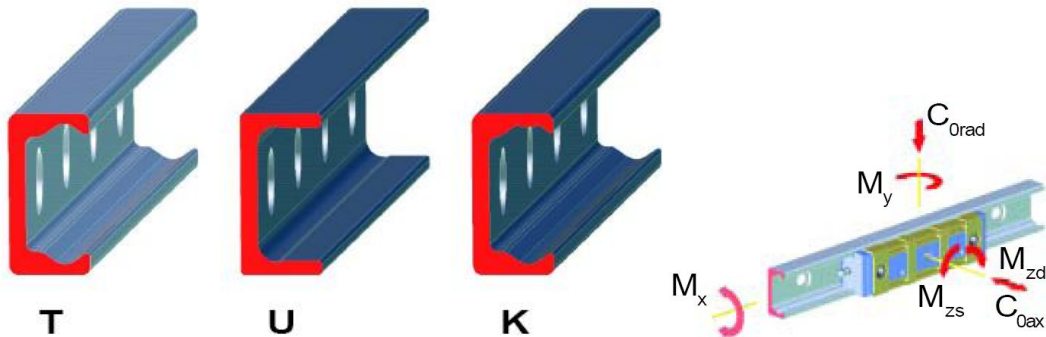

Rail sizes

Rail type	Width	Height	Fastener	Hole Pitch	Max Length	Weight [kg/m]
ULC18/TLC18	18	8.25	M4	80	2000	0.55
ULC28/TLC28	28	12	M5	80	4080	1.0
ULC43/TLC43/KLC43	43	21	M8	80	4080	2.6
ULC63/TLC63/KLC63	63	28	M8	80	4080	6.0

Rail can be supplied cut to length to suit individual requirements. For non-symmetric hole spacing please specify the G dimension (distance to first hole).

Counter sink rail is also available with some types from stock.

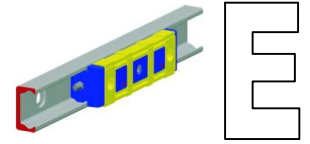

Rollon Compact Rail 18 Series Sliders

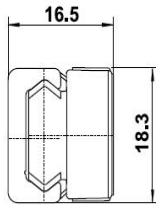

N series mounted dimensions
Rail Fasteners M4 on an 80mm
pitch

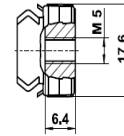
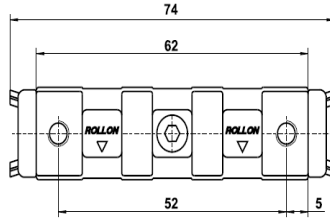

Type: **NT18**
to be utilized
with TL.18 rails

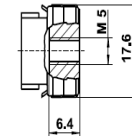

Type: **NU18**
to be utilized
with UL.18 rails

Slider type	No. rollers	Dynamic load C (100km) [N]	Static Load		M x [Nm]	M y [Nm]	M zd [Nm]	M zs [Nm]	Weight [kg]
			C0rad [N]	C0ax [N]					
NT18	3	1530	820	260	1.5	4.7	8.2	8.2	0.03
NU18	3	1530	820	0	0	0	8.2	8.2	0.03
CSW 18-60	3	1530	820	260	1.5	4.7	8.2	8.2	0.04
CSW 18-80-A	4	1530	820	300	2.8	7	8.2	24.7	0.05
CSW 18-80-B	4	1530	820	300	2.8	7	24.7	8.2	0.05
CSW 18-100	5	1830	975	360	2.8	9.4	24.7	24.7	0.06
CSW 18-120-A	6	1830	975	440	3.3	11.8	24.7	41.1	0.07
CSW 18-120-B	6	1830	975	440	3.3	11.8	41.1	24.7	0.07

Note: For CSW sliders used in U rails Coax, M x and M y are equal to 0. Normal stock items in bold type

Rollon Compact Rail 28 Series Sliders

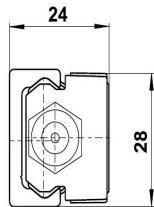

N series mounted dimensions
Rail Fasteners M5 on an
80mm pitch

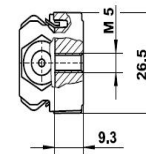
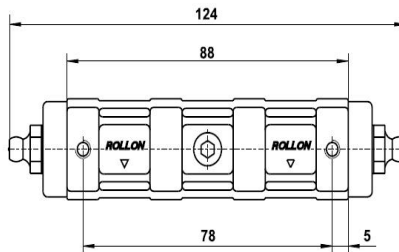

Type: **NT28**
To be utilized
with TL.28 rails

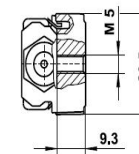

Type: **NU28**
To be utilized
with UL.28 rail:

Slider type	No. Rollers	Dynamic load C (100km) [N]	Static Load		M x [Nm]	M y [Nm]	M zd [Nm]	M zs [Nm]	Weight [kg]
			C0rad [N]	C0ax [N]					
NTE28	3	4260	2170	640	6.2	16	27.2	27.2	0.115
NUE28	3	4260	2170	0	0	0	27.2	27.2	0.115
CSW 28-80	3	4260	2170	640	6.2	16	27.2	27.2	0.155
CSW 28-100-A	4	4260	2170	750	11.5	21.7	27.2	81.7	0.195
CSW 28-100-B	4	4260	2170	750	11.5	21.7	81.7	27.2	0.195
CSW 28-125	5	5065	2580	900	11.5	29	81.7	81.7	0.24
CSW 28-150-A	6	5065	2580	1070	13.7	36.2	136.1	81.7	0.29
CSW 28-150-B	6	5065	2580	1070	13.7	36.2	81.7	136.1	0.29
CDW 28-80	3	4260	2170	640	6.2	16	27.2	27.2	0.215
CDW 28-125	5	5065	2580	900	11.5	29	81.7	81.7	0.3
NTE28L-3-A	3	4260	2170	640	6.2	29	54.4	54.4	0.2
NTE28L-4-A	4	4260	2170	750	11.5	29	54.4	108.5	0.2
NTE28L-4-B	4	4260	2170	750	11.5	29	108.5	54.4	0.2
NTE28L-4-C	4	4260	2170	750	11.5	29	81.7	81.7	0.2
NTE28L-5-A	5	5065	2580	900	11.5	29	81.7	81.7	0.2
NTE28L-5-B	5	6816	3472	640	6.2	29	54.4	54.4	0.2
NUE28L-3-A	3	4260	2170	0	0	0	54.4	54.4	0.2
NUE28L-4-A	4	4260	2170	0	0	0	54.4	108.5	0.2
NUE28L-4-B	4	4260	2170	0	0	0	108.5	54.4	0.2
NUE28L-4-C	4	4260	2170	0	0	0	81.7	81.7	0.2
NUE28L-5-A	5	5065	2580	0	0	0	81.7	81.7	0.2
NUE28L-5-B	5	6816	3472	0	0	0	54.4	54.4	0.2

Note: For CSW and CDW sliders used in U rails Coax, M x and M y are equal to 0. Normal stock items in bold type

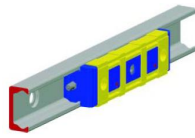
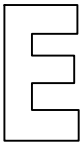

ROLLON

Rollon Compact Rail 43 Series Sliders

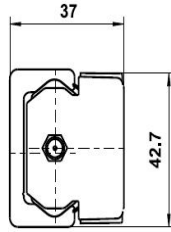

N series mounted dimensions
Rail Fasteners M8
on an 80mm pitch

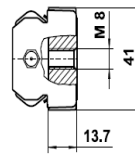
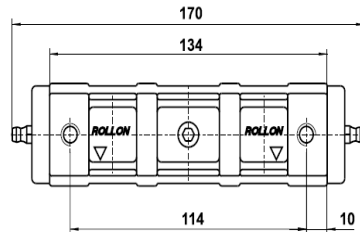

Type: **NT43**
To be utilized
with TL.43 rails

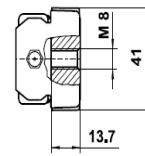

Type: **NU43**
To be utilized
with UL.43 rails

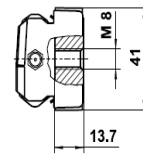

Type: **NK43**
To be utilized
with KL.43 rails

Slider type	No. Rollers	Dynamic load C (100km) [N]	Static Load		M x [Nm]	M y [Nm]	M zd [Nm]	M zs [Nm]	Weight [kg]
			C0rad [N]	C0ax [N]					
NTE43	3	12280	5500	1570	23.6	60	104.5	104.5	0.385
NUE43	3	12280	5500	0	0	0	104.5	104.5	0.385
NKE43	3	12280	5100	1320	0	50.4	96.9	96.9	0.385
CSW43-120	3	12280	5500	1570	23.6	60	104.5	104.5	0.53
CSW43-150-A	4	12280	5500	1855	43.6	81.5	104.5	313.5	0.68
CSW43-150-B	4	12280	5500	1855	43.6	81.5	313.5	104.5	0.68
CSW43-190	5	14675	6540	2215	43.6	108.6	313.5	313.5	0.84
CSW43-230-A	6	14675	6540	2215	52	135.8	313.5	522.5	1.01
CSW43-230-B	6	14675	6540	2215	52	135.8	522.5	313.5	1.01
CDW43-120	3	12280	5500	1570	23.6	60	104.5	104.5	0.64
CDW43-190	5	14675	6540	2215	43.6	108.6	313.5	313.5	0.95
NTE43L-3-A	3	12280	5500	1570	23.6	108.6	209	209	0.6
NTE43L-4-A	4	12280	5500	1855	43.6	108.6	209	418	0.6
NTE43L-4-B	4	12280	5500	1855	43.6	108.6	418	209	0.6
NTE43L-4-C	4	12280	5500	1855	43.6	108.6	313.5	313.5	0.6
NTE43L-5-A	5	14675	6540	2215	43.6	108.6	313.5	313.5	0.6
NTE43L-5-B	5	19650	8800	1570	23.6	108.6	209	209	0.6
NUE43L-3-A	3	12280	5500	0	0	0	209	209	0.6
NUE43L-4-A	4	12280	5500	0	0	0	209	418	0.6
NUE43L-4-B	4	12280	5500	0	0	0	418	209	0.6
NUE43L-4-C	4	12280	5500	0	0	0	313.5	313.5	0.6
NUE43L-5-A	5	14675	6540	0	0	0	313.5	313.5	0.6
NUE43L-5-B	5	19650	8800	0	0	0	209	209	0.6
NKE43L-3-A	3	12280	5100	1320	0	97.7	188.7	188.7	0.6
NKE43L-4-A	4	12280	5100	1320	0	97.7	188.7	377.3	0.6
NKE43L-4-B	4	12280	5100	1320	0	97.7	377.3	188.7	0.6
NKE43L-4-C	4	12280	5100	1320	0	97.7	283	283	0.6
NKE43L-5-A	5	14675	6065	1980	0	97.7	283	283	0.6
NKE43L-5-B	5	19650	8160	1320	0	97.7	188.7	188.7	0.6

Note: For CSW and CDW sliders used in U rails Coax, M x and M y are equal to 0.
Normal stock items in bold type

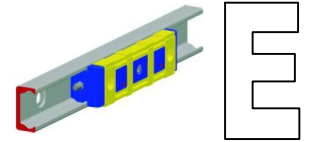

Rollon Compact Rail 63 Series Sliders

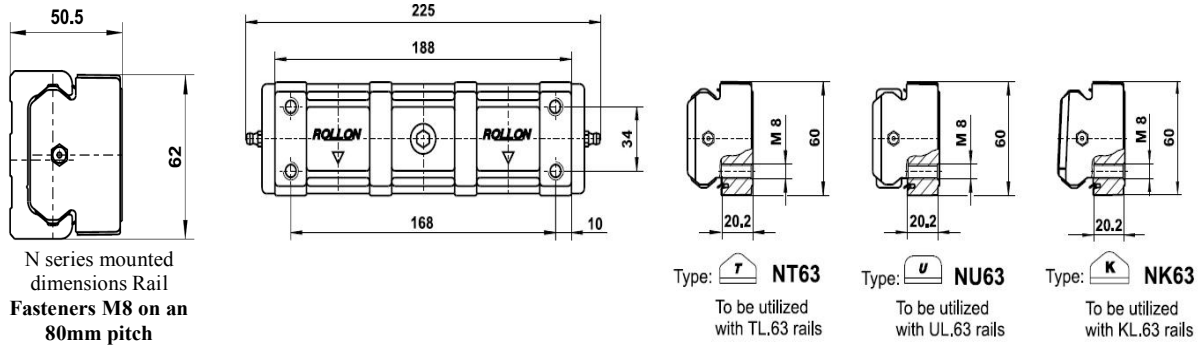

Slider type	No. Rollers	Dynamic load C (100km) [N]	Static Load		M x [Nm]	M y [Nm]	M zd [Nm]	M zs [Nm]	Weight [kg]
			C0rad [N]	C0ax [N]					
NTE63	3	30750	12500	6000	125	271	367	367	1.07
NUE63	3	30750	12500	0	0	0	367	367	1.07
NKE63	3	30750	11550	5045	0	235	335	335	1.07
CSW63-180	3	30750	12500	6000	125	271	367	367	1.66
CSW63-235-A	4	30750	12500	7200	250	413	367	1100	2.17
CSW63-235-B	4	30750	12500	7200	250	413	1100	367	2.17
CSW63-290	5	36600	15000	8500	250	511	1100	1100	2.67
CSW63-345-A	6	36600	15000	10000	350	689	1100	1830	3.17
CSW63-345-B	6	36600	15000	10000	350	689	1830	1100	3.17

Normal stock items in bold type

Corrosion protection

The slider bodies are electro nickel coated as standard and the rollers are bearing steel. When used in most applications the lubrication coating on the rollers will offer adequate corrosion protection. For more demanding applications SS rollers can be supplied in some sizes.

All rails come with electrolytic zinc plating as standard. The bearing surfaces are honed during manufacture and this eliminates the zinc plating. Once the rails are in operation a film of grease protects the raceways.

For higher corrosion protection chemical nickel plating can be applied. This coating also covers the honed part of the raceways.

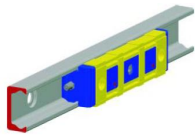

Other Rollon Product Ranges



Rollon Uniline Actuators

Compact rail integrated with a belt drive and enclosed in an aluminium extrusion. Provides a bolt in linear actuator compatible with a wide range of servo, stepper or AC motors.

Can provide rapid and reliable positioning in a great looking professional package. Can be mounted together for multi-axes applications.

All the components for Uniline actuators are stocked in NZ for short lead times, customised systems and field support.



Rollon Ecoline

A lighter weight system to a Uniline with nylon wheel sliders running within an aluminium extrusion. Provides a professional looking, quiet linear system. Up to 6m strokes and 30kg load per slider.

Timing belt linear actuator version also available and all components stocked in NZ.



Rollon Telescopic Rail

Precision telescopic solutions for high load smooth running and continuous movement. Allows compact machine sizes and offers a high quality motion. Larger variety of sizes and configurations to suit almost any application.

When a draw slide will not do, Telescopic rail is the answer.

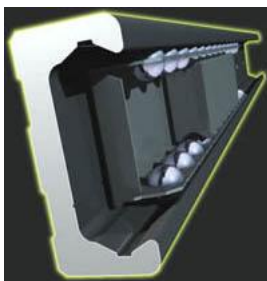

Rollon Easy Rail

Simple yet durable bearings. Offering compact dimensions, smooth motion, easy mounting all in an integrated guideway. Multiple sizes, length and multi slider options available.

Ideal for doors and protective enclosures.

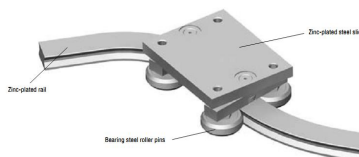

Rollon Curviline

A guide way solution for curved applications. Fixed and variable radius options available to suit almost any requirements. Durable roller sliders that follow the profile without changes to preload.